

# HDVA 600

Pure audio in perfection



Instruction manual

# Contents

<b>Important safety instructions</b> .....	<b>2</b>
<b>The HDVA 600 headphone amplifier</b> .....	<b>4</b>
<b>Package contents</b> .....	<b>5</b>
<b>Product overview</b> .....	<b>6</b>
Overview of the front panel .....	6
Overview of the rear panel .....	6
<b>Putting the HDVA 600 into operation</b> .....	<b>7</b>
Setting up the headphone amplifier .....	7
Connecting the headphone amplifier to audio sources .....	7
Integrating the headphone amplifier into an existing connection between devices (daisy-chaining the audio signal) .....	9
Connecting the headphone amplifier to the mains .....	10
<b>Using the HDVA 600</b> .....	<b>11</b>
Switching the HDVA 600 on/off .....	11
Connecting headphones .....	11
Selecting an audio source .....	12
Adjusting the signal level of the RCA input .....	13
Adjusting the volume .....	13
<b>Cleaning and maintaining the HDVA 600</b> .....	<b>14</b>
<b>If a problem occurs ...</b> .....	<b>14</b>
<b>Specifications</b> .....	<b>15</b>
<b>Manufacturer declarations</b> .....	<b>16</b>

## Important safety instructions

1. Read these instructions.
2. Keep these instructions. Always include these instructions when passing the apparatus on to third parties.
3. Heed all warnings.
4. Follow all instructions.
5. Do not use this apparatus near water.
6. Clean only with a dry cloth.
7. Do not block any ventilation openings. Install in accordance with the manufacturer's instructions.
8. Do not install near any heat sources such as radiators, heat registers, stoves, or other apparatus (including amplifiers) that produce heat.
9. Do not defeat the safety purpose of the polarized or grounding-type plug. A polarized plug has two blades with one wider than the other. A grounding type plug has two blades and a third grounding prong. The wide blade or the third prong are provided for your safety. If the provided plug does not fit into your outlet, consult an electrician for replacement of the obsolete outlet.
10. Protect the power supply cord from being walked on or pinched, particularly at plugs, convenience receptacles, and the point where they exit from the apparatus.
11. Only use attachments/accessories specified by the manufacturer.
12. Use only with the cart, stand, tripod, bracket, or table specified by the manufacturer, or sold with the apparatus. When a cart is used, use caution when moving the cart/apparatus combination to avoid injury from tip-over.
13. Unplug this apparatus during lightning storms or when unused for long periods of time.
14. Refer all servicing to qualified service personnel. Servicing is required when the apparatus has been damaged in any way, such as power supply cord or plug is damaged, liquid has been spilled or objects have fallen into the apparatus, when the apparatus has been exposed to rain or moisture, does not operate normally, or has been dropped.
15. To completely disconnect this apparatus from the AC mains, disconnect the power supply cord plug from the AC receptacle.
16. **WARNING:** To reduce the risk of fire or electric shock, do not expose this apparatus to rain or moisture.
17. Do not expose this equipment to dripping or splashing and ensure that no objects filled with liquids, such as vases, are placed on the equipment.
18. The mains plug of the power supply cord shall remain readily accessible.





### Hazard warnings on the bottom of the product

The label shown on the left is attached to the bottom of the product. The symbols on this label have the following meaning:

Presence of uninsulated dangerous voltage within the product's enclosure that may be of sufficient magnitude to constitute a risk of electric shock.

Never open the product as there is a risk of electric shock. There are no user serviceable parts inside. Always refer repairs and servicing to your authorized Sennheiser service partner.

Read and follow the safety and operating instructions contained in the instruction manual.

### Preventing damage to health and accidents

- ▶ Do not listen at high volume levels for long periods of time to prevent hearing damage.
- ▶ Keep the product, accessories and packaging parts out of reach of children and pets to prevent accidents and choking hazards.

### Preventing damage to the product and malfunctions

- ▶ If the product was moved from a cold environment to a warm one, allow the product to stand for approx. half an hour before using it.

### Intended use/Liability

The HDVA 600 is an amplifier for dynamic headphones. It can be connected to different audio sources such as hi-fi systems, turntables with preamplifiers, computers and DVD players.

This product is intended for private domestic use only. It is not suitable for commercial use.

It is considered improper use when this product is used for any application not named in this instruction manual.

Sennheiser does not accept liability for damage arising from abuse or misuse of this product and its attachments/accessories.

## The HDVA 600 headphone amplifier

The state-of-the-art HDVA 600 headphone amplifier allows you to fully exploit the potential of your high-end headphones. The HDVA 600's consistently symmetrical signal processing and extremely low harmonic distortion ensures an unadulterated and perfect music enjoyment.

The HDVA 600's output circuitry is designed for use with up to four dynamic headphones. Consistent wiring and the use of XLR-4 sockets ensures an excellent channel separation.

You can connect digital audio sources such as CD, DVD and Blu-Ray players and analog audio sources such as tuners, open reel machines and turntables with a corresponding preamplifier to the HDVA 600. Digital sources are connected via their analog outputs. The input selection rotary switch allows you to switch between the connected audio sources.

The headphone amplifier and the Sennheiser HD 800, HD 700 and HD 650 high-end headphones are optimally matched with regard to technology, design and performance characteristics and fulfil the demands of the most discerning audiophile.

### Features

- Symmetrical signal processing with exact signal transmission over the entire frequency spectrum and extremely low harmonic distortion
- Can be used with up to four dynamic headphones
- 122 dB dynamic range, wide bandwidth and high transient response due to short signal paths
- Balanced XLR-4 sockets and high-quality 1/4" (6.35 mm) jack sockets for connection of headphones
- Connection possibilities:
  - analog inputs: balanced XLR-3, unbalanced RCA
  - analog output: balanced XLR-3
- High-quality components

## Package contents

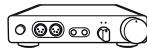

1 HDVA 600 analog headphone amplifier

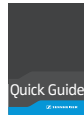

1 quick guide



1 safety guide



1 CD ROM with a detailed instruction manual as PDF

### Required accessories



A suitable and approved mains cable is available from your Sennheiser service partner.



A list of accessories can be found on the HDVA 600 product page at [www.sennheiser.com](http://www.sennheiser.com). For information on suppliers, contact your local Sennheiser partner: [www.sennheiser.com](http://www.sennheiser.com) > "Service & Support".

# Product overview

## Overview of the front panel

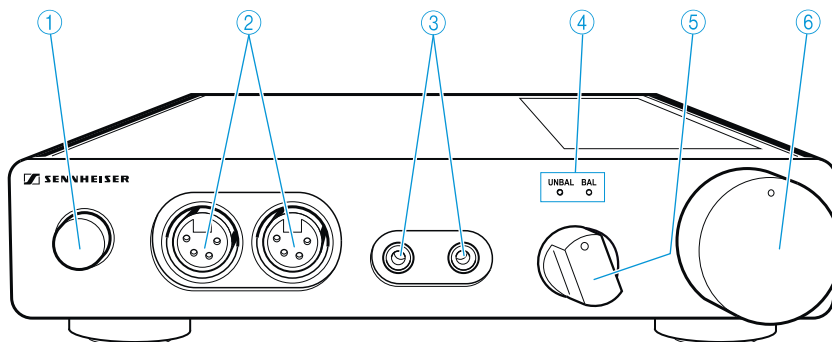

- ① On/off button
- ② Headphone outputs, XLR-4 socket, balanced
- ③ Headphone outputs, 1/4" (6.35 mm) jack socket, unbalanced
- ④ Input selection LED
- ⑤ Input selection rotary switch
- ⑥ Volume control

## Overview of the rear panel

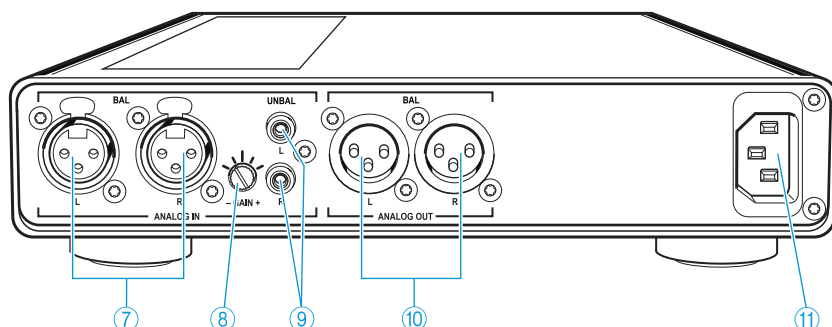

- ⑦ XLR-3 input socket, balanced (BAL L, R)
- ⑧ Input attenuation rotary switch (-GAIN+) for RCA input
- ⑨ RCA input socket, unbalanced (UNBAL L, R)
- ⑩ XLR-3 output socket, balanced (BAL L, R)
- ⑪ Mains socket

**i** The type plate and the electrical data can be found on the base of the product.

## Putting the HDVA 600 into operation

### Setting up the headphone amplifier

#### CAUTION

##### Risk of staining of furniture surfaces!

Varnish or furniture polish may degrade the feet of the product, which could stain your furniture.

- ▶ Do not place the product on delicate surfaces; if necessary, use a non-slip pad under the product.

- ▶ Place the headphone amplifier on a flat, horizontal surface.
- ▶ Ensure sufficient ventilation. The headphone amplifier generates heat which is dissipated through the housing.

### Connecting the headphone amplifier to audio sources

You can connect several audio sources to the headphone amplifier and switch between these connected sources using the input selection rotary switch.

- ▶ Switch your audio source off.
- ▶ Select a suitable high-quality connection cable for your audio source and, if necessary, a suitable adapter. Please observe the maximum recommended cable length L max.

Connection possibilities of the audio source (OUT)		Connection cable/adaptor	L max	Page
<b>A</b>	XLR-3 (analog)	2 balanced XLR-3 cables	10 m	8
<b>B</b>	RCA (analog)	Stereo audio cable with 2 RCA plugs on each end	1 m	8

- ▶ Proceed as described in the corresponding chapter.



A

Connection possibility of the audio source: analog, balanced (XLR-3)

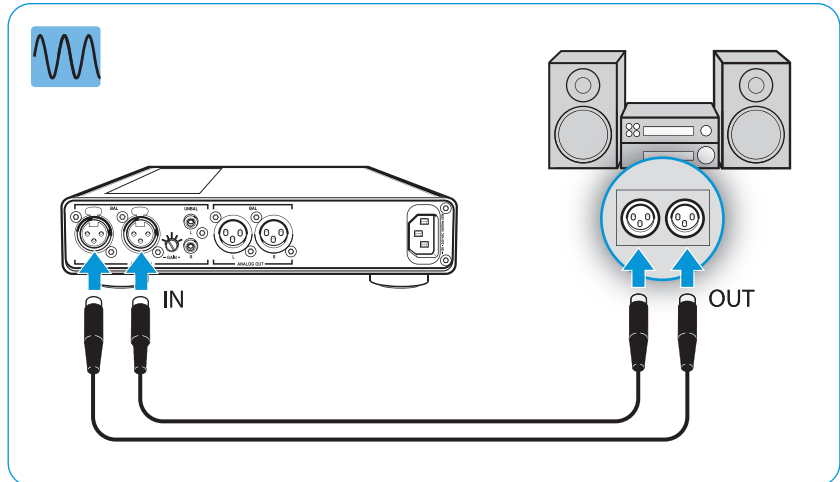

Connection cable: 2 balanced XLR-3 cables

B

Connection possibility of the audio source: analog, unbalanced (RCA)

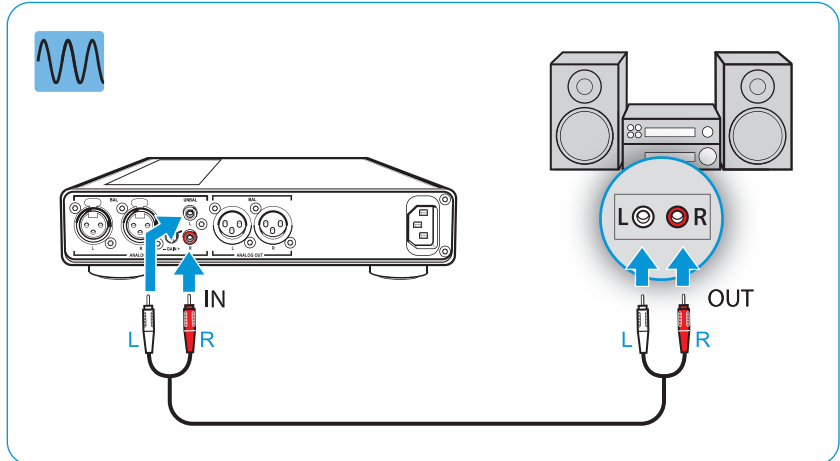

Connection cable: Stereo audio cable with 2 RCA plugs on each end

## Integrating the headphone amplifier into an existing connection between devices (daisy-chaining the audio signal)

You can integrate the HDVA 600 into an existing connection between your audio source and an additional device. By way of example of an amplifier as an additional device, this chapter describes how to integrate the HDVA 600 into an existing connection.

- ▶ Pull out the plug of the connection cable from the input IN on the amplifier.
- ▶ Connect this plug to a suitable input IN on the HDVA 600 (see page 7).

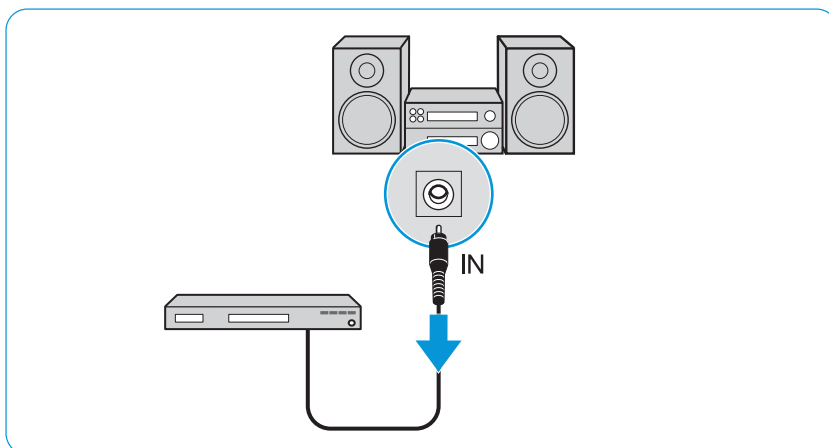

- ▶ Connect a second connection cable to the input IN on the amplifier and to the output OUT on the HDVA 600.

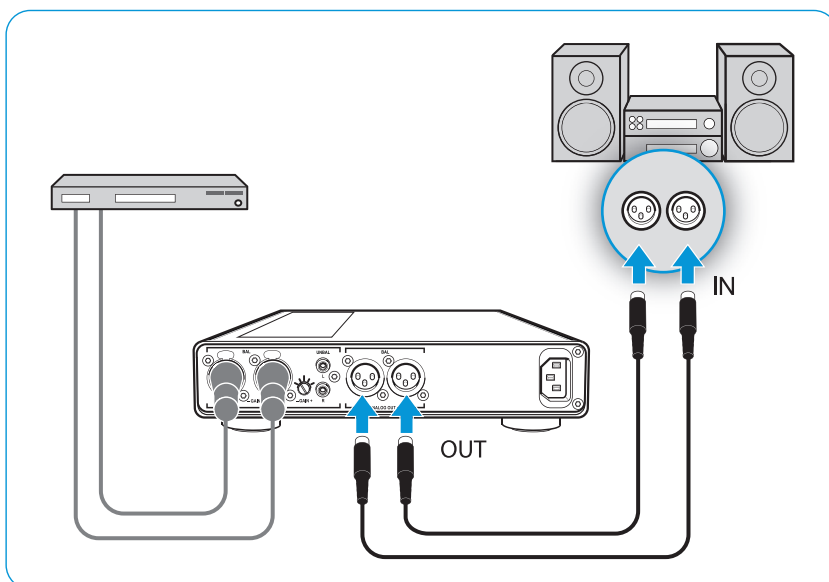

- ▶ Use the input selection rotary switch (see page 6) to select the corresponding audio source.

## Connecting the headphone amplifier to the mains

### CAUTION

#### Danger of damage to the product!

If you use an unsuitable power supply, this can cause damage to the product.

- ▶ Use a suitable mains cable to connect the product to the mains (100 to 240 V AC, 50 or 60 Hz).

- ▶ Connect the mains cable to the mains socket and a wall socket.

To disconnect the headphone amplifier from the mains:

- ▶ Unplug the mains cable from the wall socket.

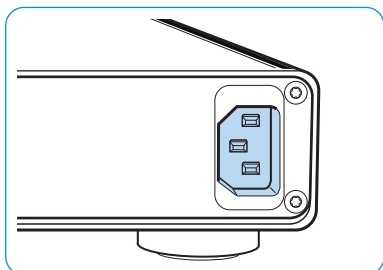

## Using the HDVA 600

### Switching the HDVA 600 on/off



#### WARNING

Hearing damage due to high volumes!

Listening at high volume levels for long periods can lead to permanent hearing defects.

- ▶ Set the volume to a low level before putting on the headphones (see page 13).
- ▶ Do not continuously expose yourself to high volumes.

- ▶ Press the on/off button.  
When the headphone amplifier is switched on, the on/off button is backlit. When you switch off the headphone amplifier, the backlighting of the on/off button goes off.

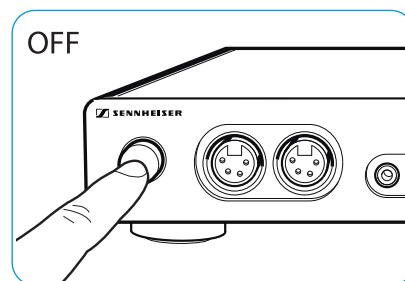
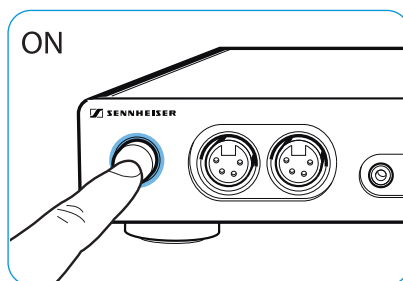

### Connecting headphones

The HDVA 600 features 2 balanced XLR-4 sockets and 2 unbalanced 1/4" (6.35 mm) jack sockets for connecting up to 4 headphones. We recommend using high-impedance headphones for an optimal listening experience.

- ▶ Connect one or several pairs of headphones.

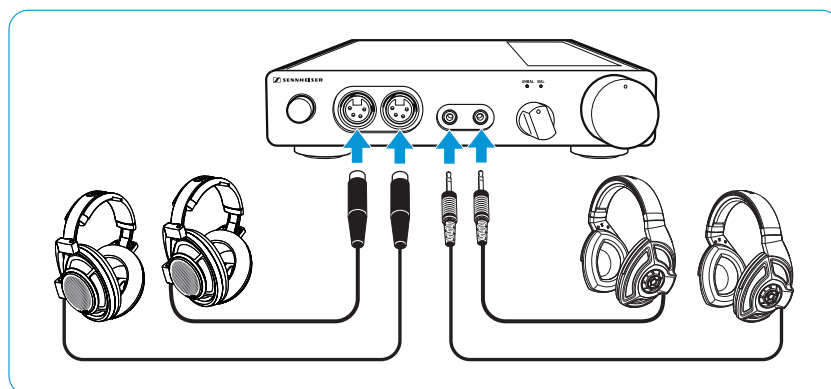

## Selecting an audio source



### WARNING



#### Danger of hearing damage!

In order to protect your hearing, before switching to a different audio source, first set the volume on the headphone amplifier to a low level. Different signal sources and different listening material (e.g. different pieces of music on different CDs) can have widely varying signal levels. In the case where you switch to a higher level signal source from a lower one without first reducing the volume level this can lead to high volume levels in the headphones and could damage your hearing.

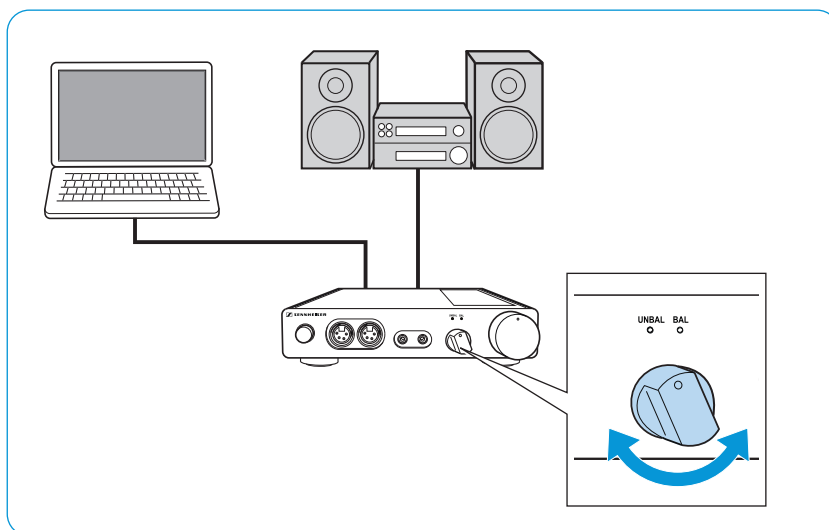
- ▶ Set the volume on the headphone amplifier to a low level (see page 13) before switching to a different audio source.



- ▶ Use the input selection rotary switch to select your connected audio source.

Switch position		Selected input on the headphone amplifier
UNBAL		RCA (analog)
BAL		XLR-3 (analog)

## Adjusting the signal level of the RCA input

In order to optimally set the gain of the headphone amplifier, you can use the input attenuation rotary switch (-GAIN+) to adjust the signal level of the RCA input.

- ▶ Turn the input attenuation rotary switch (-GAIN+) towards the + sign: if the signal is too low or  
- sign : if the signal is overmodulated.

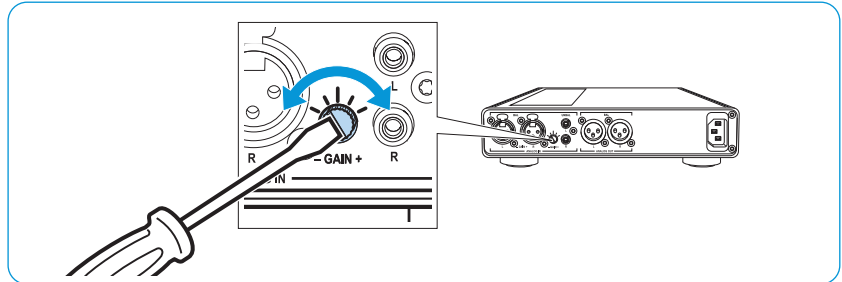

## Adjusting the volume

- ▶ Use the volume control to adjust the volume.

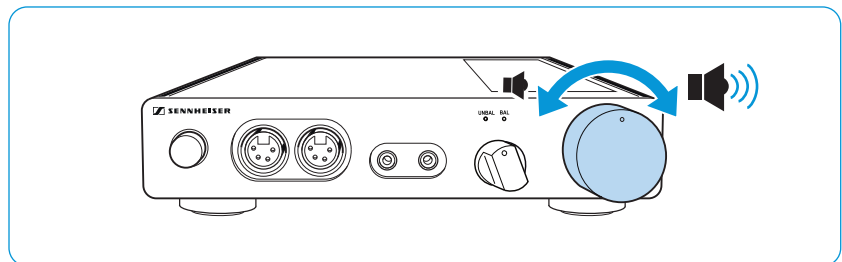

## Cleaning and maintaining the HDVA 600

### CAUTION

**Liquids can damage the electronics of the product!**

Liquids entering the housing of the device can cause a short circuit and damage the electronics.

- ▶ Keep all liquids far away from the product.
  - ▶ Do not use any cleansing agents or solvents.
- 
- ▶ Disconnect the product from the mains before cleaning.
  - ▶ Only use a dry and soft cloth to clean the product.

### If a problem occurs ...

Problem	Possible cause	Solution	Page
RCA input: signal distorted or too low	The sensitivity is adjusted too high or too low	Adjust the signal of the analog audio source.	13
Analog XLR-3 input: signal distorted or too low	The audio signal is adjusted too high or too low at the audio source	Adjust the audio signal directly at the audio source.	-

If a problem occurs that is not listed in the above table or if the problem cannot be solved with the proposed solutions, please contact your local Sennheiser partner for assistance.

To find a Sennheiser partner in your country, search at [www.sennheiser.com](http://www.sennheiser.com) > "Service & Support".

## Specifications

Dimensions (W x H x D)	approx. 224 x 44 x 306 mm
Weight	approx. 2.25 kg
Max. output power	approx. 480 mW @ 1 kHz and 600 $\Omega$ load at the XLR-4 output
Frequency response	< 10 Hz to > 100 kHz
Crosstalk attenuation	min. 93 dB @ 1 kHz
THD+N	< 0.001%
Gain	adjustable
RCA input/XLR-4 output	14 dB, 22 dB, 30 dB, 38 dB, 46 dB
Gain	
XLR input/XLR-4 output	16 dB
Dynamic range	>115 dB @ 600 $\Omega$ load (A-weighted)
Operating temperature range	0° – 45°C
<b>Power supply</b>	
Voltage range	100 – 240 V ~, 50 – 60 Hz
Power consumption	nom. 7 W (2x 300 $\Omega$ headphones connected to the XLR-4 outputs) max. 15 W (2x 16 $\Omega$ headphones connected to the ¼" (6.35 mm) jack outputs)
<b>RCA input</b>	
Max. input voltage	20 dBV (with minimum gain)
Impedance	10 k $\Omega$
<b>XLR-3 input</b>	
Max. input voltage	18 dBV
Impedance	20 k $\Omega$
<b>XLR-4 output</b>	
Pin assignment	1: L+, 2: L-, 3: R+, 4: R-, screen: GND
Impedance	min. 16 $\Omega$
<b>¼" (6.35 mm) headphone outputs</b>	
Pin assignment	tip: left, ring: right, sleeve: GND
Impedance	min. 16 $\Omega$



## Manufacturer declarations

### Warranty

Sennheiser electronic GmbH & Co. KG gives a warranty of 24 months on this product. For the current warranty conditions, please visit our website at [www.sennheiser.com](http://www.sennheiser.com) or contact your Sennheiser partner.

### In compliance with the following requirements

- WEEE Directive (2002/96/EC)



Please dispose of this product at the end of its operational lifetime by taking it to your local collection point or recycling center for such equipment.

### CE Declaration of Conformity

- EMC Directive (2004/108/EC)
- Low Voltage Directive (2006/95/EC)
- ErP Directive (2009/125/EC)
- RoHS Directive (2011/65/EU)

The declaration is available at [www.sennheiser.com](http://www.sennheiser.com).

### Statements regarding FCC and Industry Canada

This device complies with Part 15 of the FCC Rules. Operation is subject to the following two conditions: (1) this device may not cause harmful interference, and (2) this device must accept any interference received, including interference that may cause undesired operation.

This class B digital apparatus complies with the Canadian ICES-003. Changes or modifications made to this equipment not expressly approved by Sennheiser electronic Corp. may void the FCC authorization to operate this equipment.

### Trademarks

Sennheiser is a registered trademark of Sennheiser electronic GmbH & Co. KG. Other product and company names mentioned in this instruction manual may be the trademarks or registered trademarks of their respective holders.

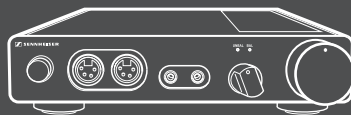

 **SENNHEISER**

Sennheiser electronic GmbH & Co. KG

Am Labor 1, 30900 Wedemark, Germany  
[www.sennheiser.com](http://www.sennheiser.com)

Publ. 03/13, 549747/A02